

Instructions

Compact pressure transmitter

PT216CC



Product Introduction

The PT216CC pressure transmitter is based on the silicon piezoresistive pressure core measurement principle. Compact all-stainless steel welded structure and extremely stable electronic components make it very strong and reliable.

Application

1. Hydraulic and pneumatic techniques
2. Pump and compressor
3. machine building
4. Ship and navigation

Functional Characteristics

1. -0.1~0 MPa to 0~60MPa measurement range
2. Multiple output signal selection
3. Available in absolute and gauge pressure types
4. Multiple electrical interface options
5. Multiple international universal process connections

Technical Parameters

Pressure range	-0.1~0MPa to 0~60MPa
Pressure type	Absolute pressure, gauge pressure
Accuracy	±0.5%FS、 ±0.25%FS
Output signal	See the output signal and performance parameter table for details
Power supply	See the output signal and performance parameter table for details
Process connection	See the output signal and performance parameter table for details
Electrical connection	See the electrical connection table for details
Overload pressure	1.5 times the rated pressure
Rupture pressure	Three times the rated pressure
Ambient temperature	-20~85℃

Storage temperature	20~85 °C
Temperature of liquid medium	-20~105 °C
Response time	<2ms
Protection degree	IP65, IP67
Fluid material	304 stainless steel and 17-4 PH stainless steel

Table of output signals and performance parameters

Output signal	Signal features	Power supply	Load resistance (Ω)
4~20mA	two-wire system	9~30Vdc	<(Power supply voltage-9) / 20 mA
0~10Vdc	three-wire system	12~30Vdc	>20k
0.1~10.1Vdc	three-wire system	12~30Vdc	>20k
0.2~10.2Vdc	three-wire system	12~30Vdc	>20k
1~10Vdc	three-wire system	12~30Vdc	>20k
2~10Vdc	three-wire system	12~30Vdc	>20k
0~5Vdc	three-wire system	8~30Vdc	>20k
0.1~5.1Vdc	three-wire system	8~30Vdc	>20k
1~5Vdc	three-wire system	8~30Vdc	>20k
1~6Vdc	three-wire system	8~30Vdc	>20k
0.5~4.5Vdc proportional output	three-wire system	3.3~5Vdc	>20k
0.5~4.5Vdc Absolute output of 5VDC for power supply	three-wire system	5Vdc	>20k
0.5~4.5Vdc Absolute output of the high-voltage powersupply	three-wire system	8~30Vdc	>20k

Appearance size

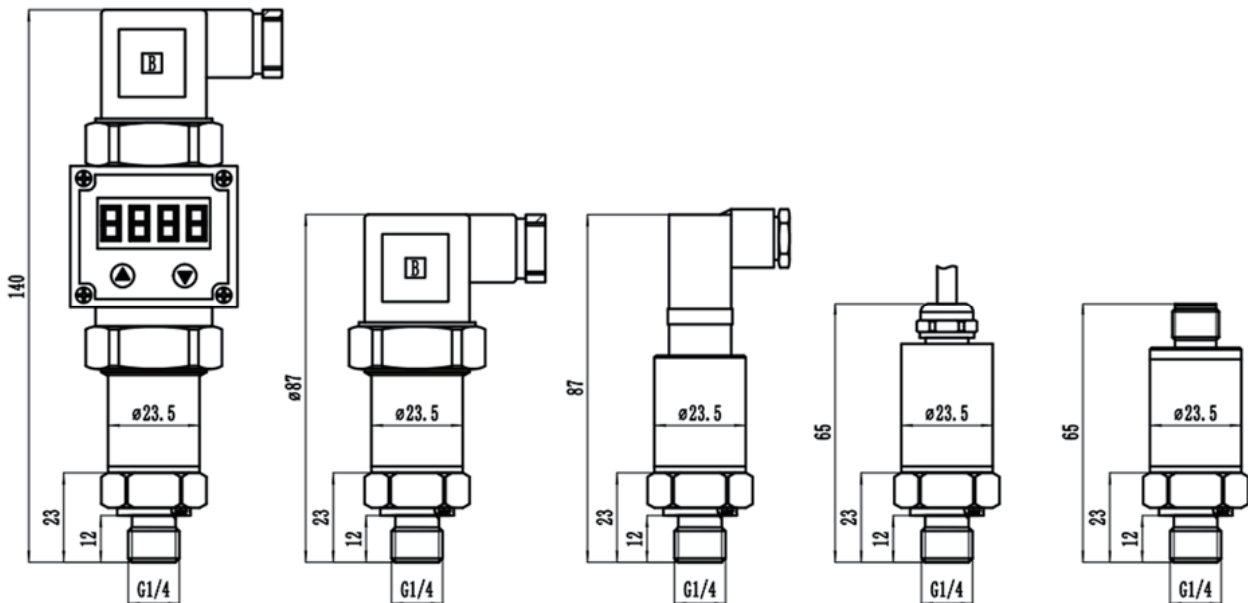

Pulse buffer selection

Gasitation, water hammer, and pressure peaks may occur in product applications, especially in hydraulic systems, e. g. When quickly closing the valve or when the pump is up and down, these phenomena may be on the sensor evil. PT210CC Provide a pressure pulse buffer to eliminate these harmful peaks and protect the sensor. Please note for a pulse buffer.

Process connection of ANSI / ASME B1.20.1/ISO/KS Internal Thread, EN837 Internal Thread, The SAE 04 SA4395-E is unable to select a pulse buffer

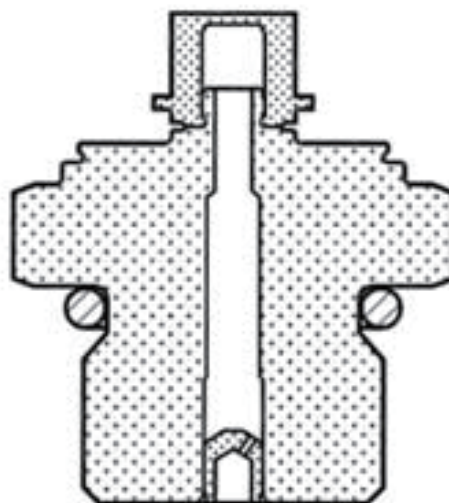

Process connection

DIN EN ISO 11792-2(Formerly DIN3852-E)

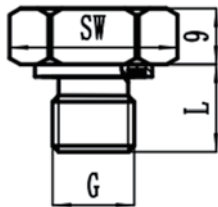

G	L(mm)	SW(mm)	Selection code
G1/4A	14	24	M-G1/4
G1/2A	17	27	M-G1/2
M14×1.5	14	24	M-M14
M20×1.5	17	27	M-M20
G1/8A	12	24	M-G1/8

EN837、DIN16288

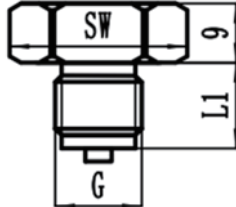

G	L(mm)	SW(mm)	Selection code
G1/4B	13	24	N-G1/4
G3/8B	16	24	N-G3/8
G1/2B	20	24	N-G1/2
M20×1.5	20	24	N-M20

DIN3852-A

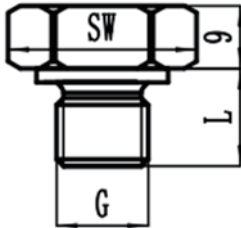

G	L(mm)	SW(mm)	Selection code
G1/4A	14	24	O-G1/4
G3/8A	14.5	24	O-G3/8
G1/2A	17	27	O-G1/2

EN837内螺纹

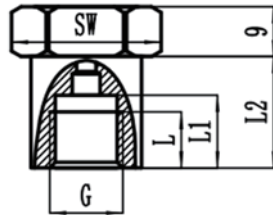

G	L(mm)	L1(mm)	SW	Selection code
G1/8	7.5	10	24	P-G1/8
G1/4	10	13	24	P-G1/4
G3/8	12	16	24	P-G3/8
G1/2	15	19	27	P-G1/2

SAE J514 E

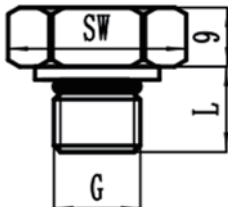

G	L(mm)	SW(mm)	Selection code
7/16-20UNF	12	24	Q-7U
9/16-20UNF	13	24	Q-9U

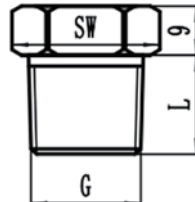

ANSI/ASME B1.20.1/ISO/KS

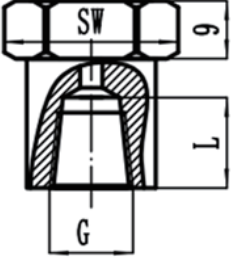
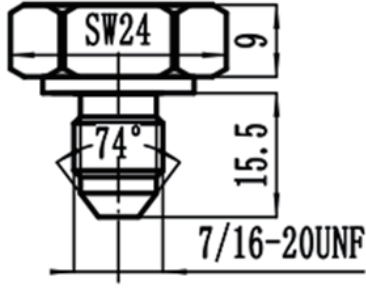

G	L(mm)	SW(mm)	Selection code
1/8NPT	10	24	S-1/8NPT
1/4NPT	13	24	S-1/4NPT
1/2NPT	19	24	S-1/2NPT
R1/4/PT1/4	13	24	S-R1/4
R3/8/PT3/8	15	24	S-R3/8
R1/2/PT1/2	19	24	S-R1/2

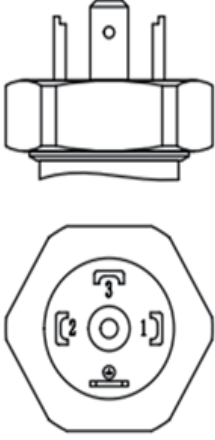

ANSI/ASME B1.20.1/ISO/KS Selection code				SAE 04 SA4395-E (Selection code U-7U)	
					
G	L(mm)	SW(mm)	Selection code		
1/8NPT	11	24	T-1/8NPT		
1/4NPT	14	24	T-1/4NPT		
1/2NPT	20	24	T-1/2NPT		
R1/4/PT1/4	11	24	T-R1/4		
R3/8/PT3/8	16	24	T-R3/8		
R1/2/PT1/2	20	24	T-R1/2		

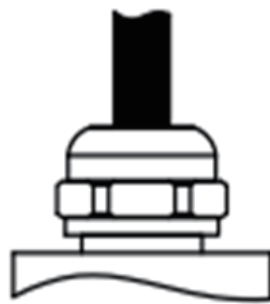
Electrical joint

DIN 175301-803 A Hessman connector (IP65 protection class)	DIN 175301 803 C Hessman connector (IP65 protection class)
	
M12x1 (4-pin) Circular Airline Plug (IP67 Protection class)	Waterproof joint outlet (IP67 protection class)
	

Electrical connection

If the product provided has been equipped with cable, please directly according to the color of the cable, please do the correct wiring according to the pin definition

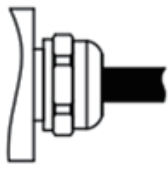
DIN 175301-803 A Hessman connector			
Wiring terminal	Electrical connection	Two-wire system of 4-20 mA / cable color	Three-wire system voltage output / cable color
1		Power supply positive / red	Power supply positive / red
2		Signal positive / black	Power negative/signal negative/ black
3			Signal positive / green
DIN 175301-803 C Hessman connector			
Wiring terminal	Electrical connection	Two-wire system of 4-20 mA / cable color	Three-wire system voltage output / cable color
1		Power supply positive / red	Power supply positive / red
2		Signal positive / black	Power negative/signal negative/ black
3			Signal positive / green
M12x1(4-pin) circular aviation plug			
Wiring terminal	Electrical connection	Two-wire system of 4-20 mA / cable color	Three-wire system voltage output / cable color
1		Power positive / brown	Power positive / brown
2			
3		Signal positive / blue	Signal positive / blue
4			Power negative/signal negative/ black
DIN 175301-803 C Hessman connector			
Wiring terminal	Electrical connection	Two-wire system of 4-20 mA / cable color	Three-wire system voltage output / cable color
Red		Power supply positive	Power supply positive
Black		Signal positive	Power negative/signal negative
Green/Blue			Signal positive

Ordering guide

Series guide	PT216CC	-	X	-	X	X	-	X	-	X	-	X	-	X	-	X
Pressure type	Gauge pressure		G													
	Absolute pressure		A													
Pressure Unit	bar				B											
	MPa				B											
	psi				M											
	kPa				P											
Pressure range	Pressure Range Value x					X										
Product connection	See the process connection selection code for details							X								
Output signal	Two-wire system 4~20mA								MA							
	Three-wire system 0~10Vdc								10V							
	Three-wire system 0.1~10.1Vdc								10V1							
	Three-wire system 0.2~10.2Vdc								10V6							
	Three-wire system 1~10Vdc								9V							
	Three-wire system 2~10Vdc								8V							
	Three-wire system 0~5Vdc								5V							
	Three-wire system 0.1~5.1Vdc								5V3							
	Three-wire system 1~5Vdc								4V2							
	Three-wire system 1~6Vdc								5V4							
	Three-line system 0.5~4.5Vdc proportional output								4V3							
	Three-wire system 0.5~4.5Vdc absolute output 5VDC power supply								4V							
	Three-wire system 0.5~4.5Vdc absolute output high voltage power supply								4V1							
	Electrical connection	DIN 175301-803 A Hessman connector								1D						
DIN 175301 803 C Hessman connector								2D								
DIN 175301-803 A Hessman connector with LED display(output signal is only 4-20mA)								3D								
M12x1(4-pin) circular aviation plug								T								
Nylon joint outlet line "X" meters								MNx								
Metal waterproof joint outlet "X" meters								MDx								
Pulse buffer	No pulse buffer is required								--							
	A pulse buffer is required								N							
Accuracy	0.5%FS												--			
	0.25%FS													2A		
Specific requirements	Please consult for other special requirements															...