

Instructions

Melt Temperature Sensor

MTT Series



attestation

ISO 9001:2015

Please read this instruction manual carefully before installation



Content

- 1.Introduction
- 2.Application
- 3.Product features
- 4.Technical data
- 5.Dimensions
- 6.Cable housing
- 7.Tip type
- 8.Electrical connection
- 9.Ordering guide
- 10.Installation and removal
- 11.Transport and storage

Introduction

MTT Series melt temperature sensor is suitable for temperature measurement of melt, fluid, gas, etc. The forms of temperature sensor are various . While reducing the medium flow resistance, the sensitive part of the probe is completely placed in the measurement medium, with higher measurement accuracy, shorter response time, better reliability and long life etc.

Application

Petrochemicals,Textile&chemical fiber,Plastics&rubber etc

Product features

- Temperature Range from 0-700°C
- 4-20mA output is optional
- Different thermocouple and RTD are optional
- Different Shapes of tip is available

Technical data

Thermocouple	J Type,K Type,PT100
Accuracy	Class A
Temperature	0-700°C
Material	SUS304
Withstand voltage rating	Max70MPa
Process connection	1/2-20UNF,M18×1.5,M14×1.5
Probe form	Flat,Conical type,Cylindrical type,Blade shape
Temp measurement terminal form	Insulation
E-connection	Thermocouple,Leading wire,7-pin aviation connector

Dimensions

Standard Rotatable Rigid Stem (Code:HD)

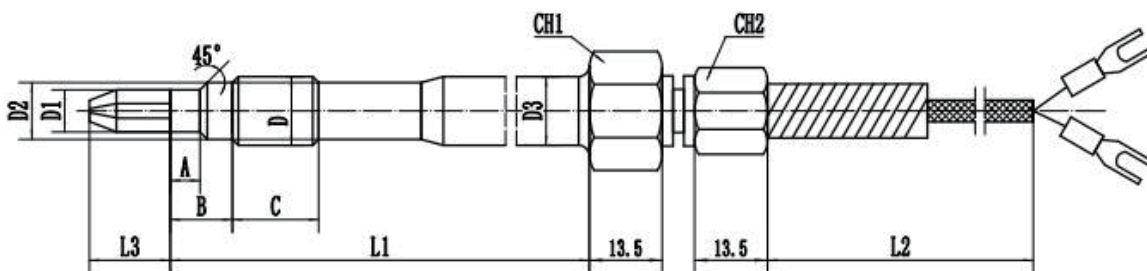

Standard Fixed Rigid Stem (Code:FI)

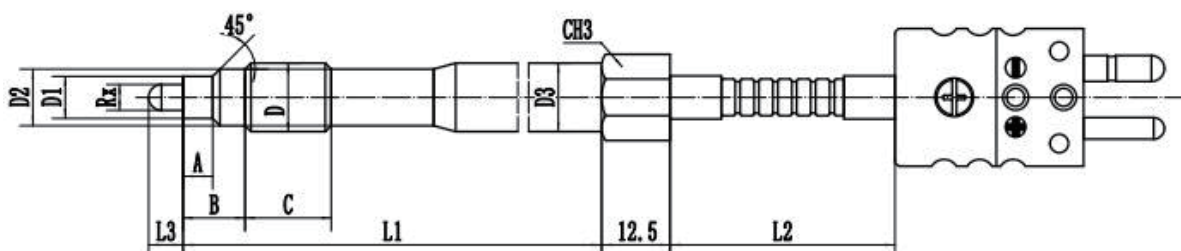

D	D1	D2	D3	A	B	C	CH1	CH2	CH3
1/2-20UNF	φ7.8	φ10.5	φ12.7	5.5	11.5	16	19	14	16
M14×1.5	φ7.8	φ11.5	φ12.7	5.5	11.5	16	19	14	16
M16×1.5	φ9.8	φ13.5	φ15.8	5.5	13	20	19	14	19
M18×1.5	φ9.8	φ15.8	φ17.8	8	14	20	19	14	19

Fixed Rigid Stem with Thread Lengthened Type (Code:Cx)

“x” means thread length x mm

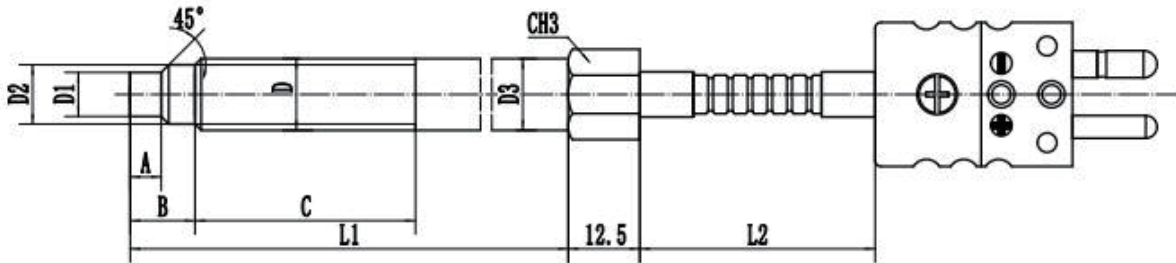

D	D1	D2	D3	A	B	CH3
1/2-20UNF	φ7.8	φ10.5	φ12.7	5.5	11.5	16
M14×1.5	φ7.8	φ11.5	φ12.7	5.5	11.5	16
M16×1.5	φ9.8	φ13.5	φ15.8	5.5	13	19
M18×1.5	φ9.8	φ15.8	φ17.8	8	14	19

Rotatable Rigid Stem with Y Type (Code:YH)

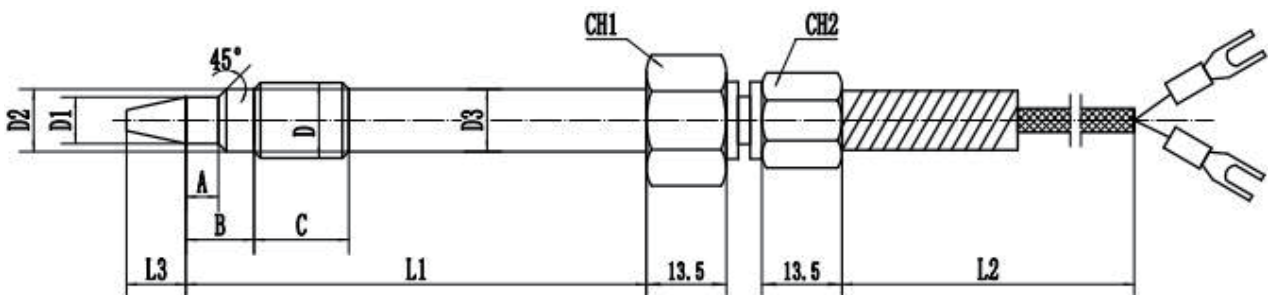

Fixed Rigid Stem with Y Type (Code:YF)

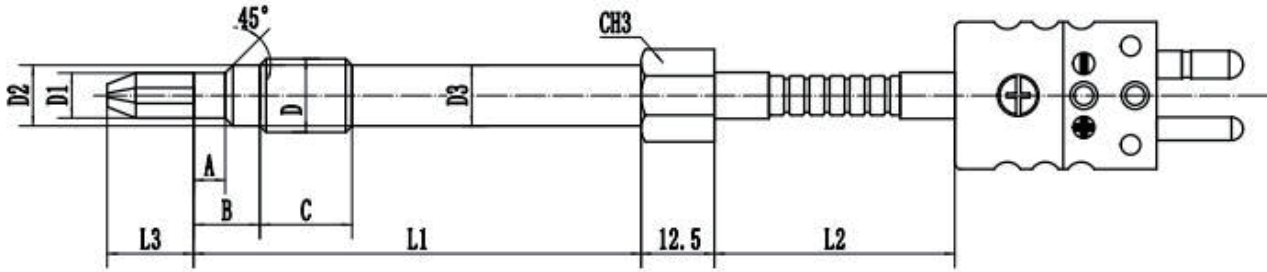

D	D1	D2	D3	A	B	C	CH1	CH2	CH3
1/2-20UNF	φ7.8	φ10.5	φ10.5	5.5	11.5	16	19	14	16
M14×1.5	φ7.8	φ11.5	φ11.5	5.5	11.5	16	19	14	16
M16×1.5	φ9.8	φ13.5	φ13.5	5.5	13	20	19	14	19
M18×1.5	φ9.8	φ15.8	φ15.8	8	14	20	19	14	19

Cable housing

None (Code:FN)

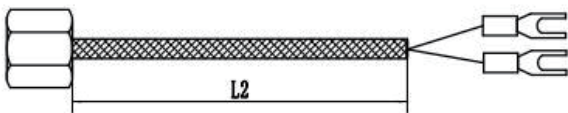

Metal bellow (Code:FY)

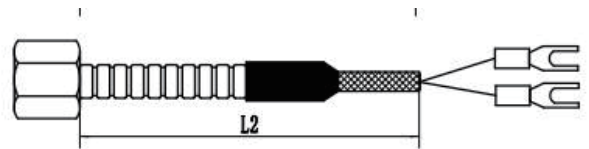

Stainless steel tube (Code:FT)

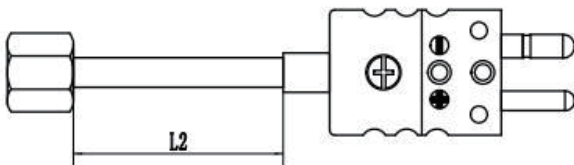

Tip type

Blade type (Code:L)

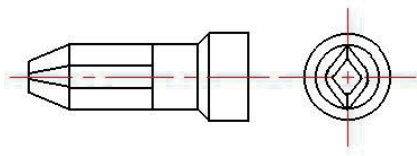

Oval type (Code:T)

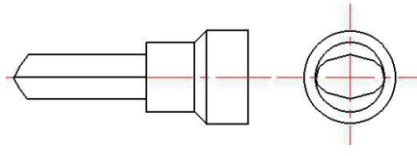

Conical type (Code:C)

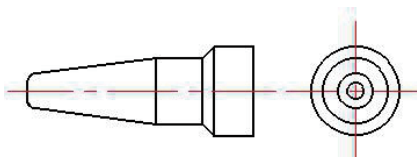

Flat Head shape (Code:F)

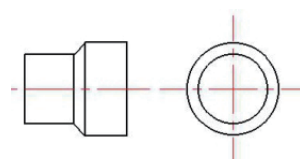

Electrical connection

Thermocouple plug board (Code:P)

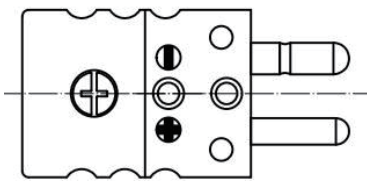

Leading wire Y Terminal (Code:W)

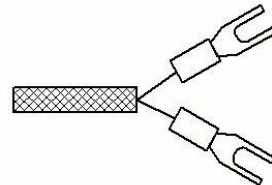

M16 connector (7-PIN) (Code:T)

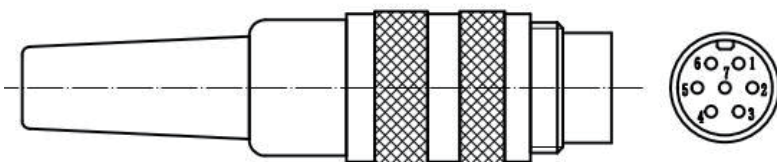

M16	PIN	2-wire TC and RTD	3-wire Pt100	4-wire Pt100	2-branch 2-wire Pt100	2-branch 3-wire Pt100
	1	+	+	+	+	+
	2			+		
	3	-	-	-	-	-
	4		-	-		-

Ordering guide

Serie No	MTT	X	-	X	-	X	-	X	-	X	-	X	-	X	-	X	-	X
Temperature type	Thermocouple J type	J																
	Thermocouple E type	E																
	Thermocouple K type	K																
	2-wire PT100	RTD																
	3-wire PT100	RTD1																
	4-wire PT100	RTD7																
	2-branch 2-wire PT100	RTD2																
	2-branch 3-wire PT100	RTD10																
	2-branch 4-wire PT100	RTD11																
Process connection	1/2-20UMF			1/2														
	M14×1.5			M14														
	M16×1.5			M16														
	M18×1.5			M18														
Rigid stem length (L2)	76mm					3												
	102mm					4												
	152mm					6												
	203mm					8												
	228mm					9												
	318mm					12												
	Other length					Xmm												
	Flex stem length (L2)	102mm							4									
152mm								6										
460mm								18										
760mm								30										
Other length								Xmm										
Cable housing	None									FN								
	Metal bellow									FY								
	Stainless bellow									FT								
Tip type	Blade type										L							
	Oval type										T							
	Round type (diameter xmm)										Rx							
	Conical type										C							
	Flat type										F							
Tip length(L3)	Length Xmm (Other standard length are 5mm,10mm,15mm,Standard flat type is L0)												Lx					
Tip material	SUS304												--					
	SUS316												3L					
	Hastelloy-C276												C2					
E-connection	Leading wire (Y terminal)															W		
	Leading wire (Round terminal)															W1		
	Thermocouple plug board															P		
	M16 connector (7-PIN)															T		
	Explosion-proof junction box															J		
	Plug-in locking connector															B		
Rigid stem type	Standard fixed rigid stem																	FI
	Standard rotatable rigid stem																	HD
	Fixed rigid stem with thread lengthened type (Thread length xmm)																	Cx
	Rotatable rigid stem with Y type																	YH
	Fixed rigid stem with Y type																	YF

Installation & Removal

Installation

When installing the melt temp sensor, the sensor hole should be within the size requirement marked in following drawing and the assembly accuracy can be checked by testing bolts. Before installing the sensor, first clean the impurities in the hole and between the threads, then the thread of the sensor is coated with heat-resistant slurry, the screw teeth can be avoided. The installation force is very important, the installation torque of the rupture disk can only act on the shaft (hexagon), do not apply any force to its head. The housing should be kept away from high temperature areas.

1/2-20 UNF /M14×1.5= Maximum starting torque: 40Nm

M18 x 1.5 = Maximum starting torque: 50 Nm

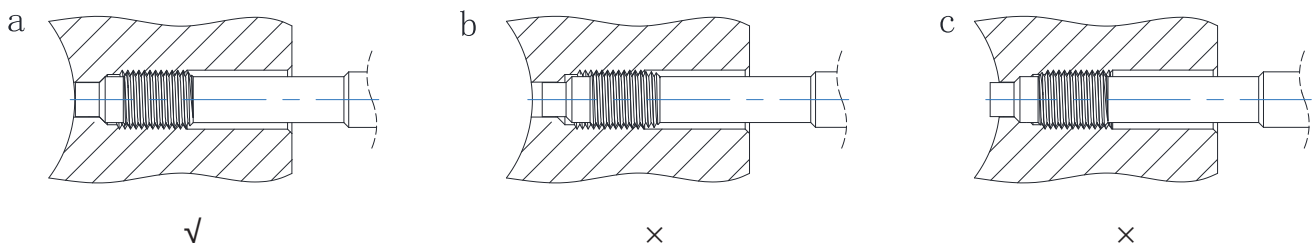

Removal

The removal of sensor must be done under heated conditions (plastic melting point). When remove the sensor, please note that the diaphragm has no contact pressure. The force to remove the sensor must only be applied on the shaft (hexagon), and do not apply any force to the head of the sensor.

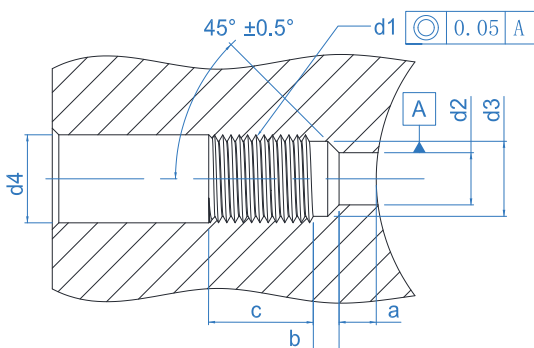

d1	M18×1.5	M14×1.5	1/2-20UNF-2A
d2	∅ 9.9 ^{+0.1}	∅ 7.9 ^{+0.1}	∅ 7.9 ^{+0.1}
d3	∅ 16.1 ^{+0.1}	∅ 11.7 ^{+0.1}	∅ 10.7 ^{+0.1}
d4	∅ 20	∅ 15	∅ 14
a	6.1 ^{-0.1}	5.7 ^{-0.1}	5.7 ^{-0.1}
b	4 ^{-0.2}	3.2 ^{-0.2}	3.2 ^{-0.2}
c	25	19	19

Transport and storage

The temperature probe and thread of MTT series are protected by a cap, which should be tightened at any time in storage and only opened when installed.